

ST27-DC1222 1/24 Ford GT #66 Daytona 2019
ST27-CD12008 1/12 ZX-RR Carbon decal

¥2,376
¥2,160

REPRODUCTION

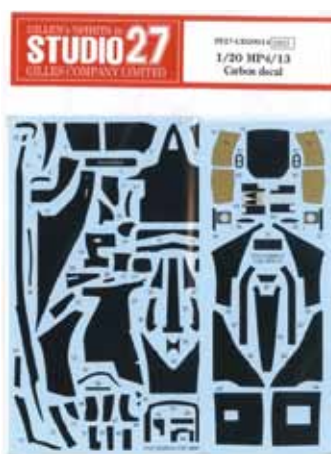

ST27-DC1221 1/20 Stratos Turbo #539 Giro D' Italia 1977
ST27-CD20014 1/20 MP4-13 Carbon decal
ST27-CD20028 1/20 F310B Carbon decal

¥2,592
¥3,024
¥3,024

contact us ~お問い合わせ先~



有限会社 ジル GILLES COMPANY LIMITED

〒252-0815 神奈川県藤沢市石川1-9-3
《1-9-3, Ishikawa, Fujisawa Kanagawa Japan》

tel: 0466-90-3312
fax: 0466-90-3313

E-mail info@studio27.co.jp

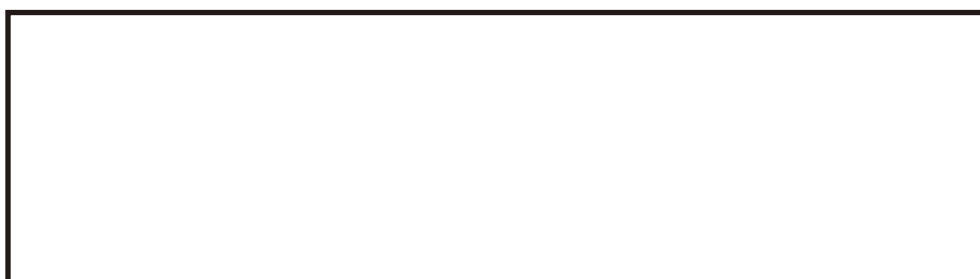

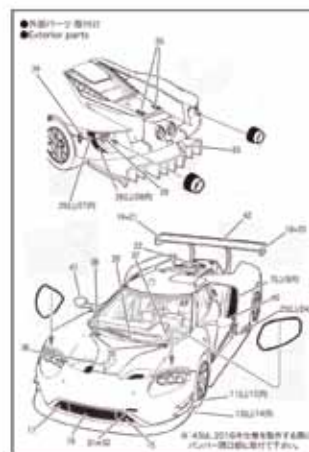
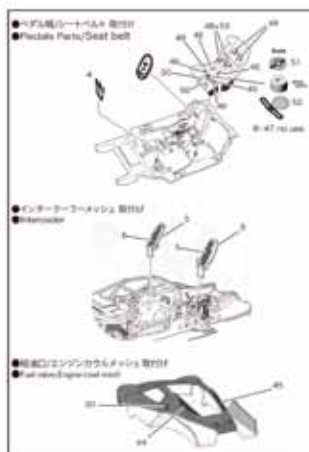
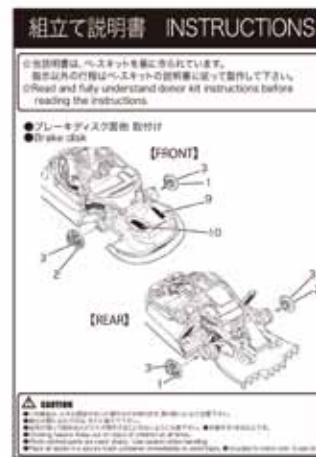
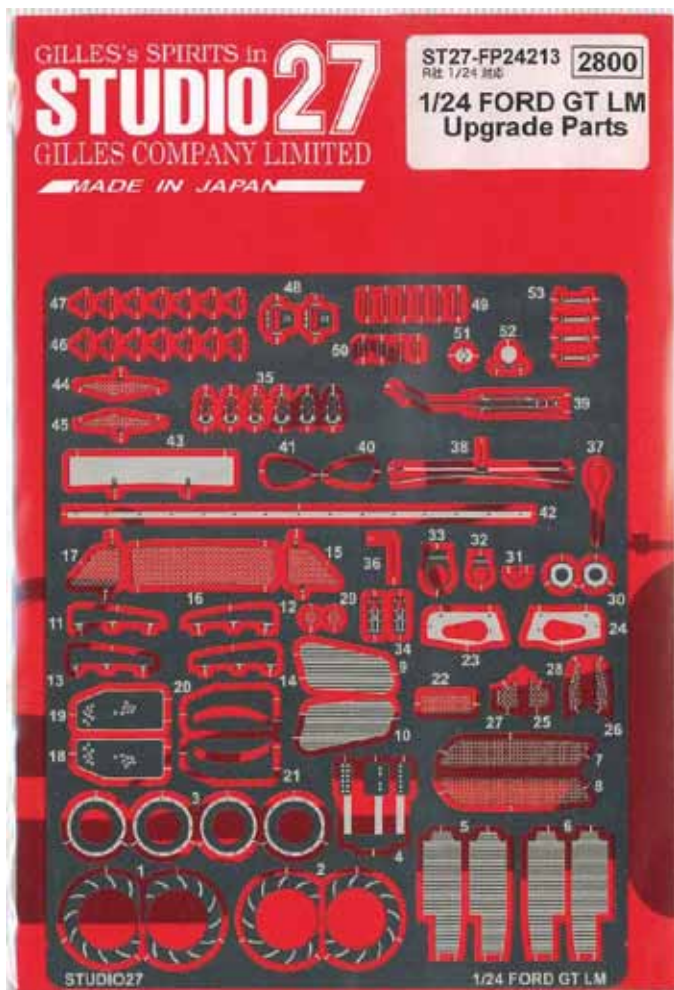

ST27-FP24213

1/24 Ford GT LM Upgrade Parts

¥3,024

REPRODUCTION

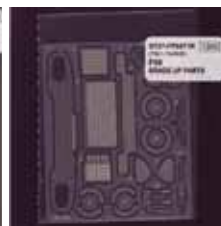

ST27-FP20136
ST27-FP20142
ST27-FP2464R
ST27-FP2470R
ST27-FP2471R
ST27-FP24212

1/20 F1-2000 Upgrade Parts
1/20 F310B Upgrade Parts
1/24 ENZO Upgrade Parts
1/24 F40 Upgrade Parts
1/24 F50 Upgrade Parts
1/24 R91CP Upgrade Parts

¥3,240
¥3,240
¥1,296
¥1,512
¥1,296
¥3,024

641 Brazilian GP 1990

少量限定再生産

■ フェラーリ641 ■

スクーデリア・フェラーリが、1990年開幕戦アメリカGP、ブラジルGP、サンマリノGP(プロストのみ)に投入したマシン。
ブラジルGPでは、プロストが優勝、マンセルが4位に入る好成績を納めました。



TAMIYA 1/20 FERRARI F189後期型対応【ITEM 20024】

1/20 641 ブラジルGP 1990 トランスキット 【ST27-TK2033R】 ¥14,040(税込)

製品内容：ボディ、アンダートレイがウレタン、シート、ラジエータ、サスカバー、ヘッドレスト、
メーターパネル等がホワイトメタル。エッチングパーツ、デカール、シートベルトリボン付属。



JANコード: 4545310018612



ウレタンレジンパーツ
メタルパーツ

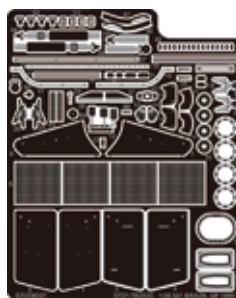

エッチングパーツ



マーキングデカール

ST27-TK2033R

1/20 641 Brazilian GP 1990 conversion kit

¥14,040