

1/24 scale Multimedia kit

R8

SPA 2014



組立説明図

ASSEMBLY INSTRUCTIONS

製作上の注意

- レジンパーツは、組立、塗装前に離型剤落とし等で洗浄して下さい。
- 組立には、瞬間接着剤、エポキシ系ボンドをご使用下さい。
- メタルパーツは、バリ、パーティングライン等処理した後、プライマー、プラサフ等で下地処理をして下さい。
- 各パーツの組立においては、入念に仮組みを行ってから接着して下さい。
組立には、十分な削り合わせ等が必要な部分もありますので、十分ご注意ください。



CAUTION

- Read carefully and understand all instructions fully before assembly.
- Take extra care when using sharp tools to avoid injuries.
- When using paint and cement (not included) read and follow their instructions.
- Use epoxy or CA glue only.
- Keep away from reach of children.
- Model for collectors. Not suitable for under 18 years old.
- Replacement available within one year for missing and sub-standard parts only while stock last.

PARTS DETAIL

R : RESIN PARTS レジンパーツ

C : CLEAR PARTS クリアパーツ

W : WOOD PARTS ウッドパーツ

M : METAL PARTS メタルパーツ

V : VAC-FORMED PLASTIC バキュームパーツ

E : ETCHING PARTS エッチングパーツ

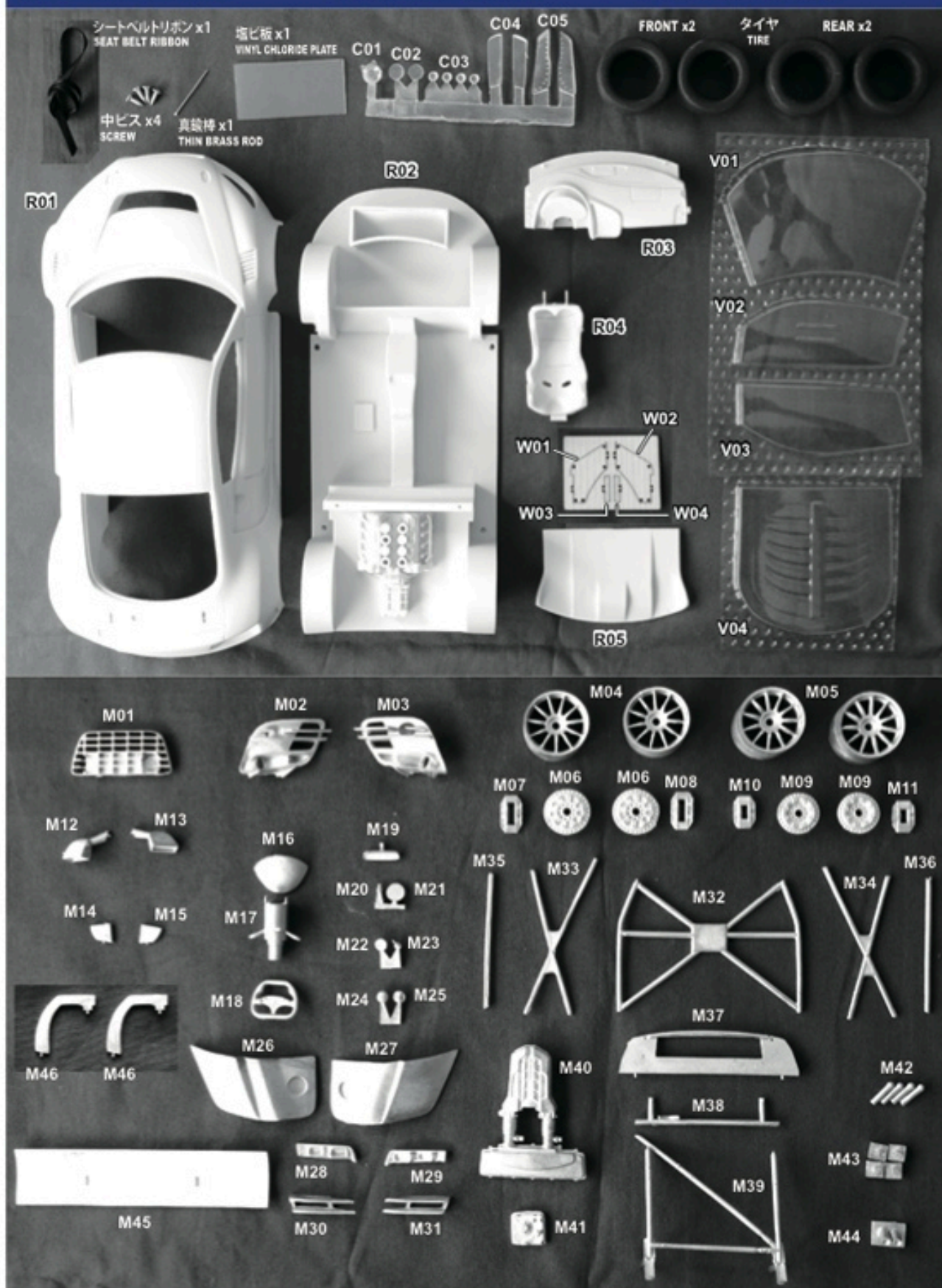

DECAL GUIDE

※ ()内は反対側です。
opposite side.

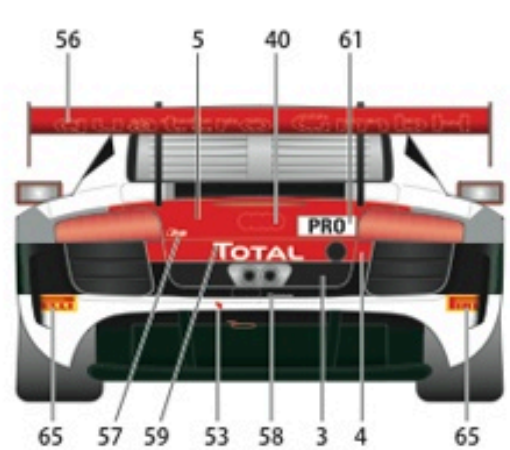
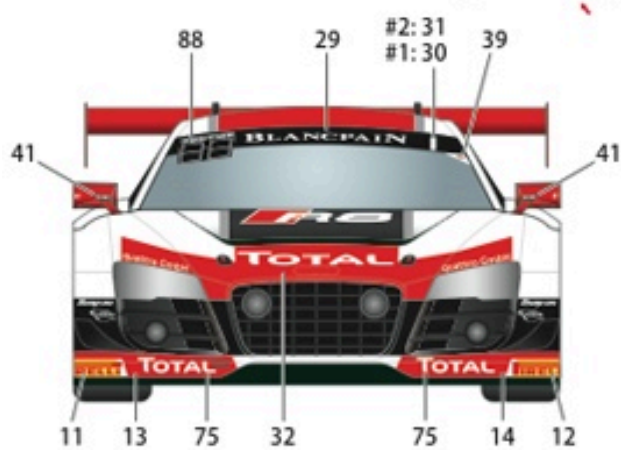
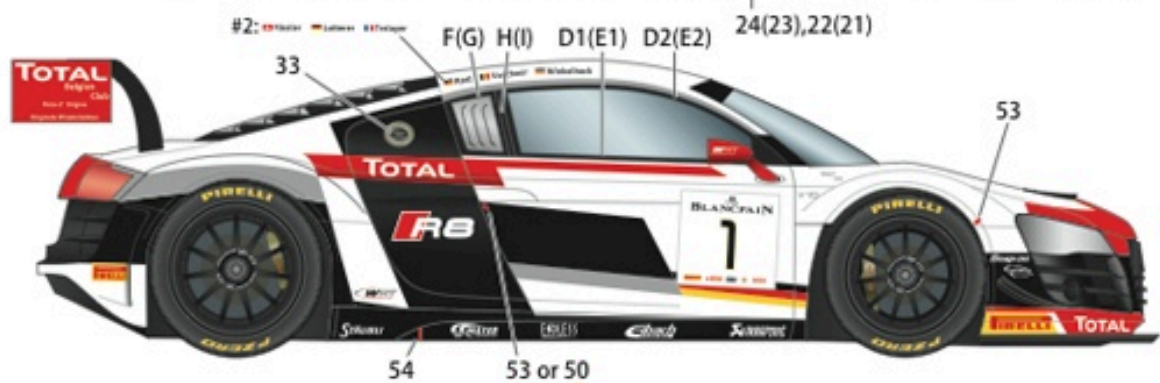
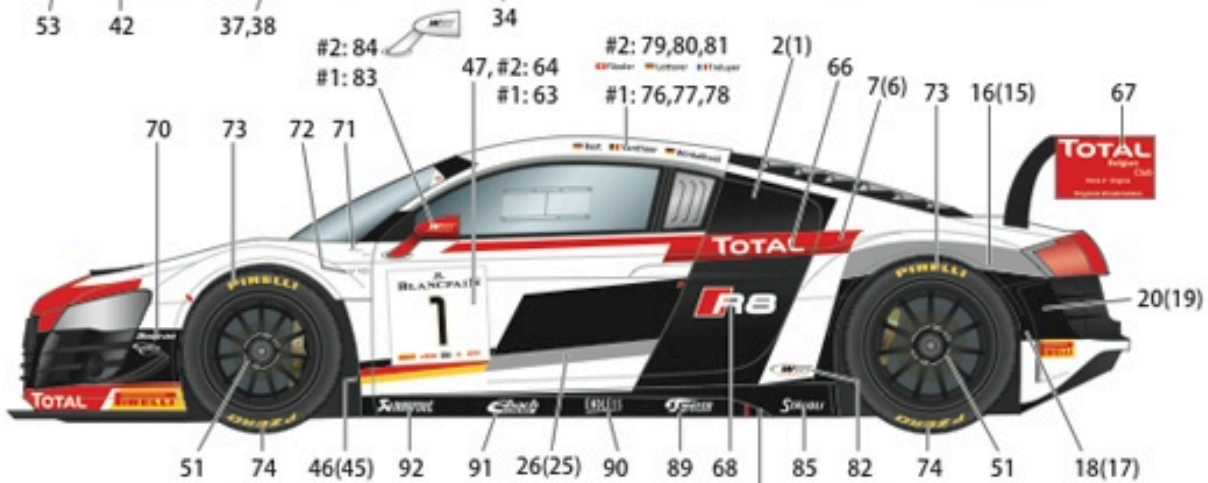
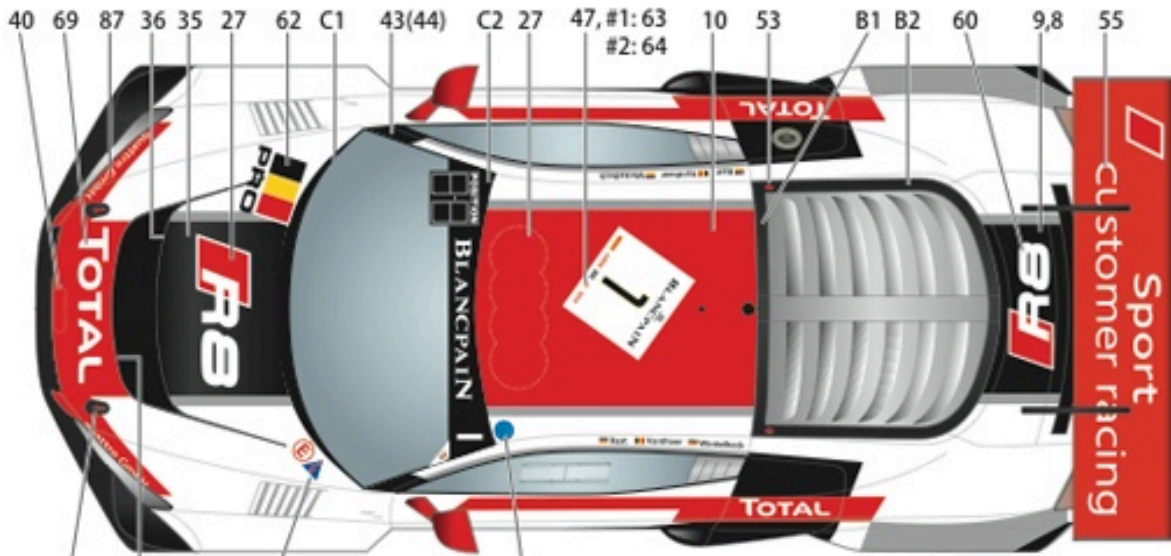

PARTS DETAIL

デカール
DECAL X 5



エッチング
ETCHING PARTS X 1

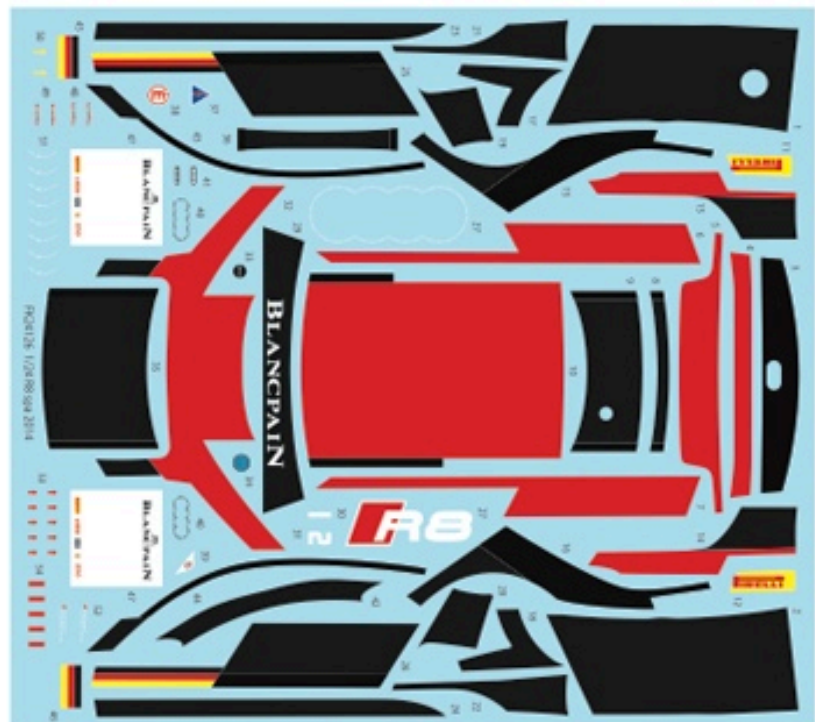
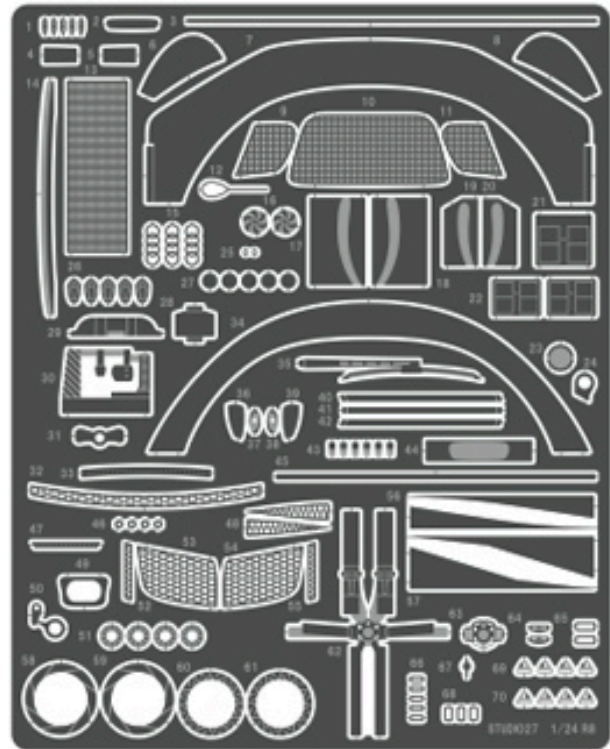

RECOMMENDED COLOR GUIDE 推奨ペイントガイド (TAMIYA COLOR)

BLK BLACK: ブラック	SBK SEMI GLOSS BLACK: セミグロスブラック	MBK MATT BLACK: マットブラック	GLD GOLD: ゴールド (X-31)	RED RED: レッド (X-7)
SLV SILVER: シルバー (X-11)	WHT WHITE: ホワイト	CRD CLEAR RED: クリアーレッド	POL POLISH: ポリッシュ	

① Dashboard steering

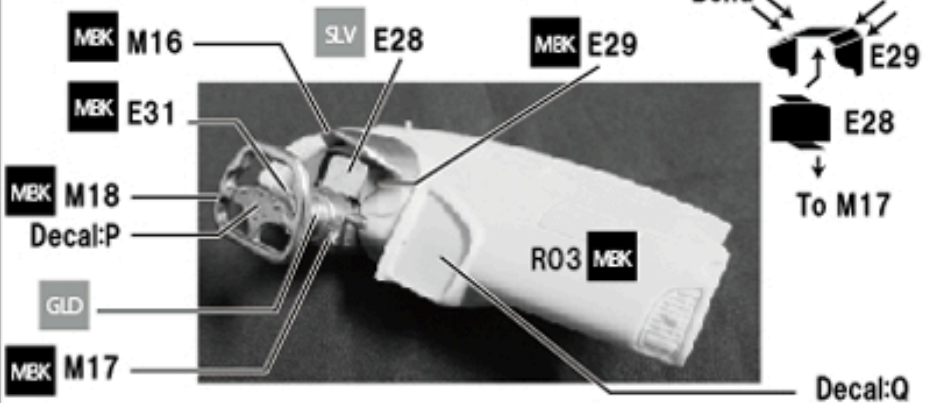

② Brake

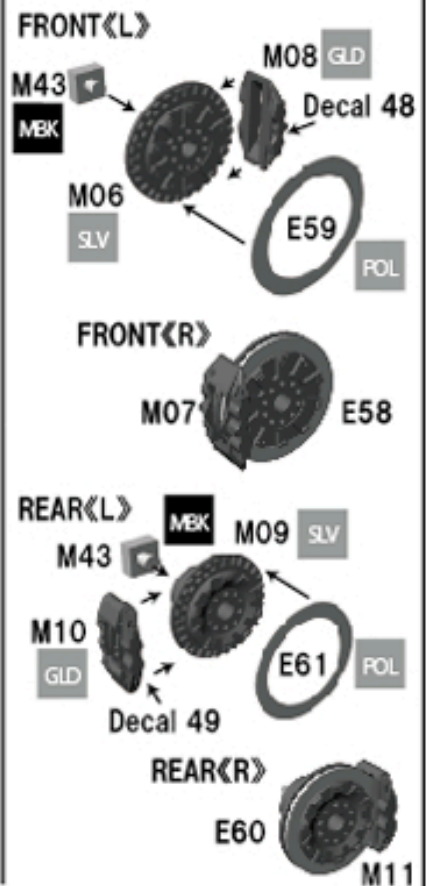

③ Rear diffuser

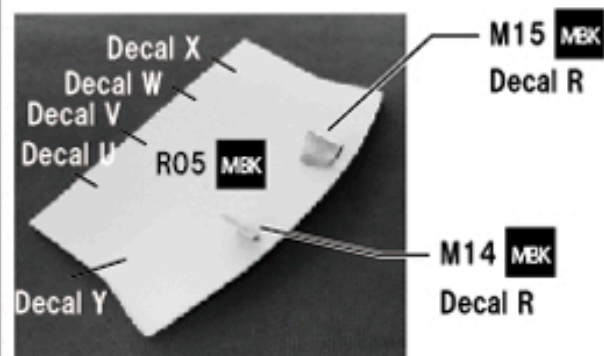

④ Rear wing

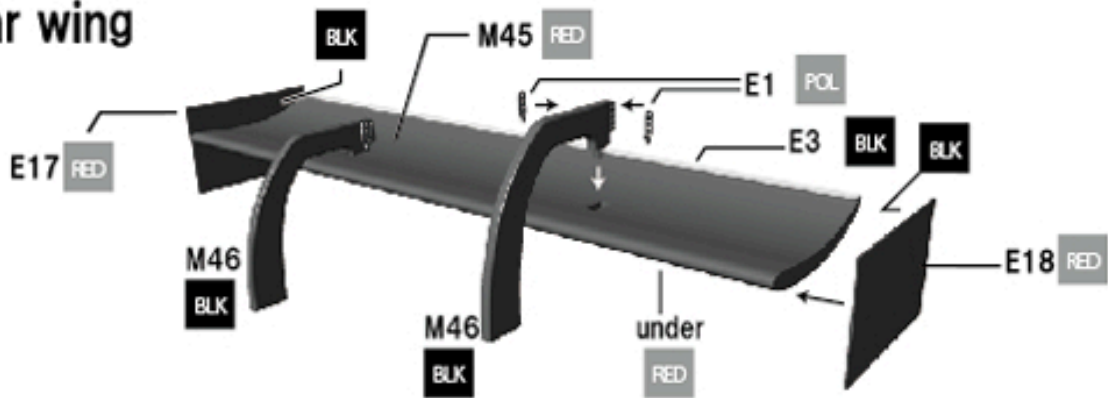

⑤ Front spoiler

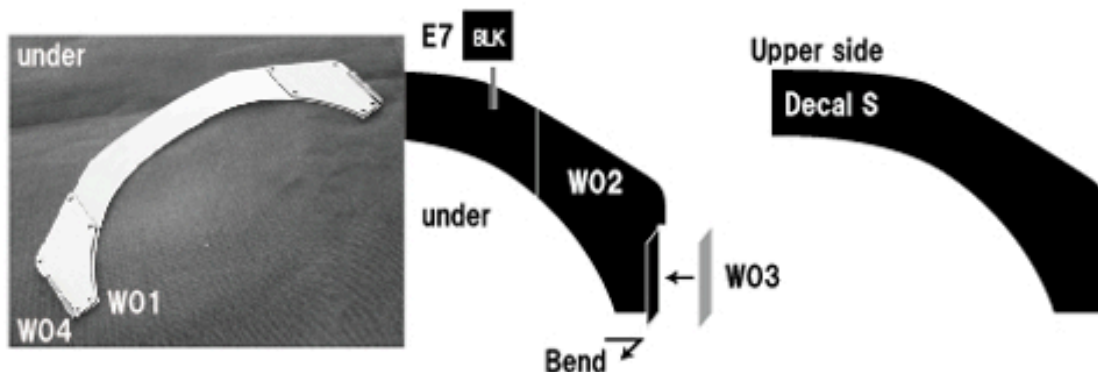

⑥ Chassis

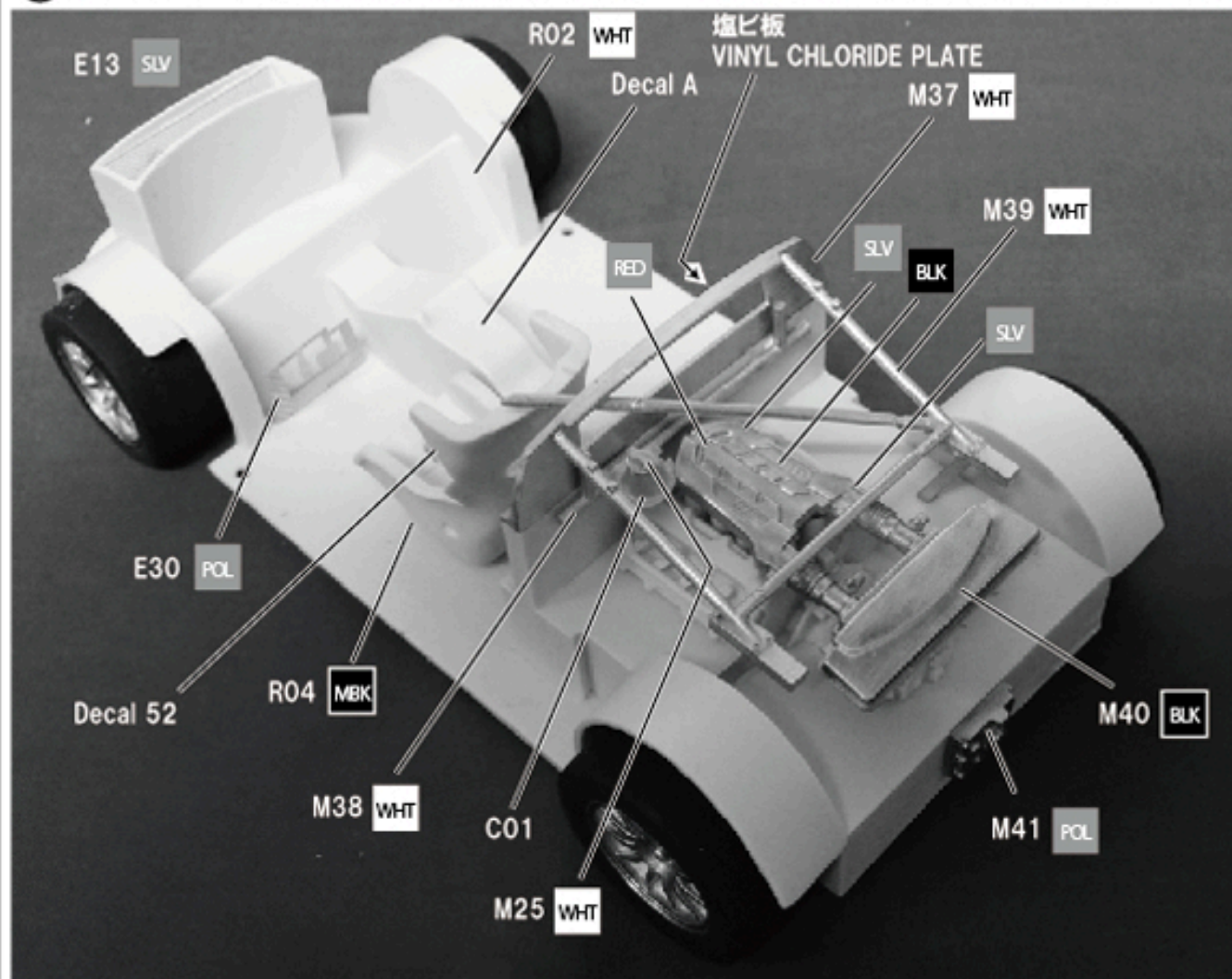

Notice

組付けの際にロールバーとの干渉に注意
time of assembling



塩ビ板カットガイド
VINYL CHLORIDE PLATE
Cutting guide

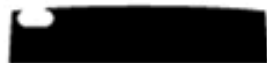

⑦ Seat belts

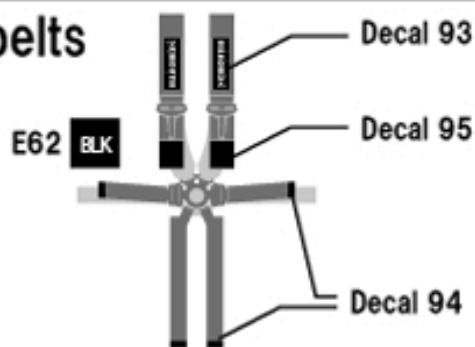

⑧ Wheel

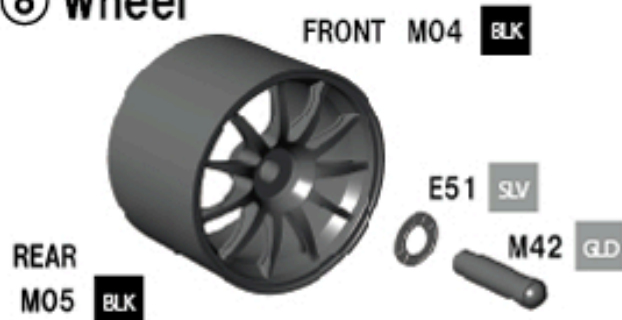

⑨ Body

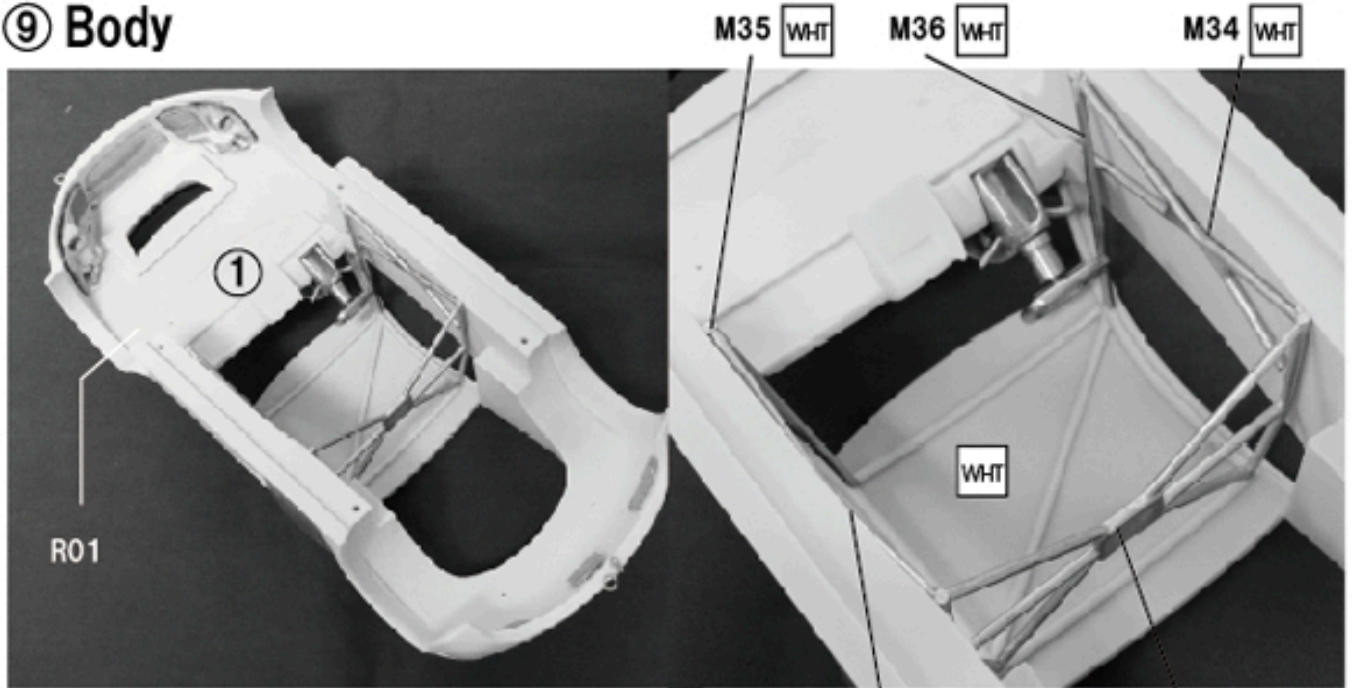

FRONT

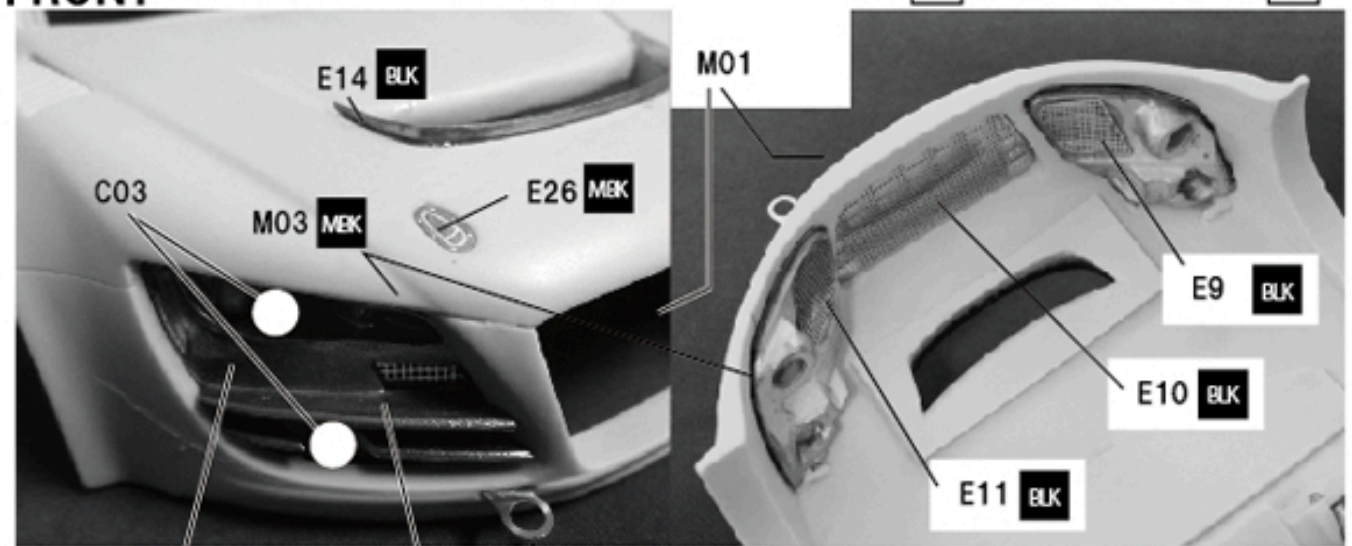

REAR

Decal L (M) ,N (O) Decal J (K) E24 (RED)

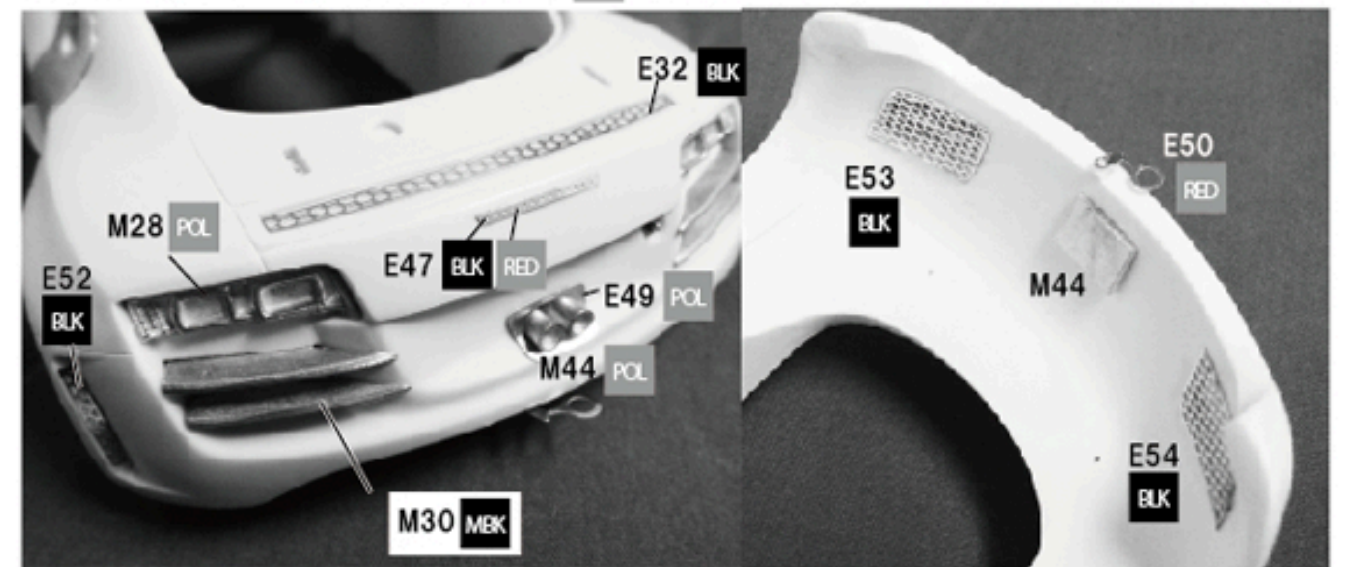

組付イメージ

Image assembled

